

AIR BOOSTER

Model: AB-2

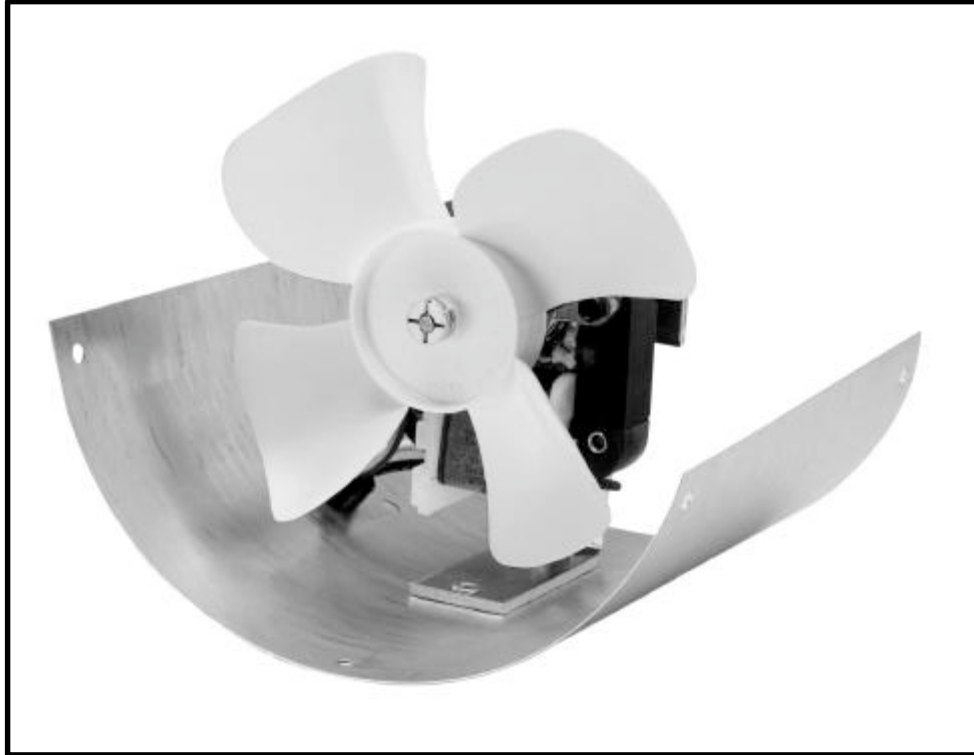

The Air Booster is designed to increase the flow of heated air or cooled air in branch ducts of a heating and central air conditioning system. The Air Booster, can also be used to improve the air flow of a gravity warm air furnace.

The Air Booster should be installed in branch ducts serving individual rooms, where proper air flows can not be achieved.

Note: *Installer must supply junction box.*



FIELDCONTROLS
THE VENTING SOLUTIONS COMPANY

2630 Airport Road • Kinston, NC 28504
Phone: 252-522-3031 • FAX: 252-522-0214
Automated Fax Literature Service: 1-800-385-9460
www.fieldcontrols.com

INSTALLATION

The Air Booster is not designed for installation in the main air supply ducts. Locating the Air Booster near the outlet end of a problem branch duct will provide the best performance.

The Air Booster is designed to operate in round ducts 6-inches in diameter or larger and rectangular ducts 6-inches wide by 6-inches deep or larger.

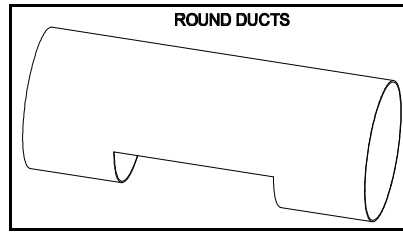

Figure 1A

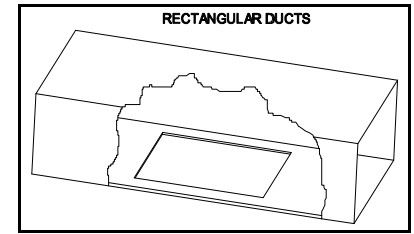

Figure 1B

CAUTION: Do not install the Air Booster where the air temperature within the duct exceed 180°F. The Air Booster should not be installed into vertical duct pipes.

1. Locate the Air Booster in the duct pipe near the problem area. Allow adequate space for the removal of the unit for servicing or annual inspection.

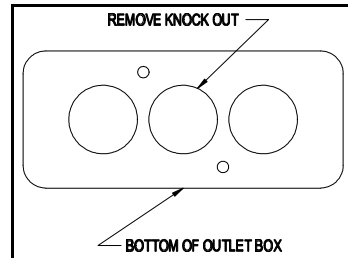

Figure 2A

2. Attach the self-adhesive template provided to the duct surface. Make sure the arrows on the template point in the direction of the desired air flow. After the template has been secured to the duct pipe, cut a slot in the pipe along the indicated lines on the template. Then remove the remainder of the template from the pipe. (See Figure 1A or 1B)

3. Insert the Air Booster into the slot, making sure the fan blade points in the direction of the air flow. Position the Air Booster so the fan blade does not rub against the inside surface of the duct. Mark on the duct the location of the 6-hole positions in the base plate. Remove the Air Booster and drill 1/8-inch diameter holes through the duct pipe where indicated.

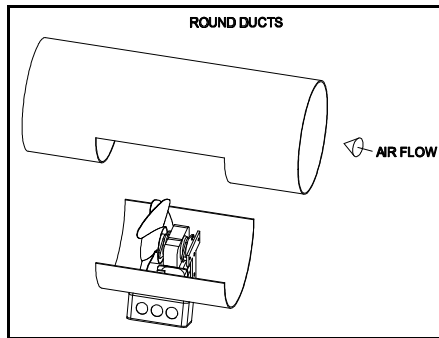

Figure 3A

4. Remove center knockout from the installer supplied outlet box bottom. (See Figure 2A) Before installing Air Booster into the duct pipe, fasten the outlet box onto the base plate with the #10-32 UNF screws and nuts provided. (See Figure 2B)

5. Insert the Air Booster into the cut slot of the duct pipe. Make sure the fan blade is pointed toward the outlet of the duct. Secure the Air Booster onto the duct with the sheet metal screws provided. (See Figure 3A or 3B)

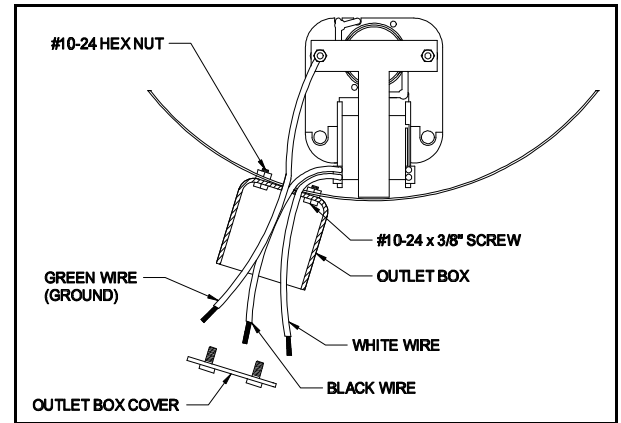

Figure 2B

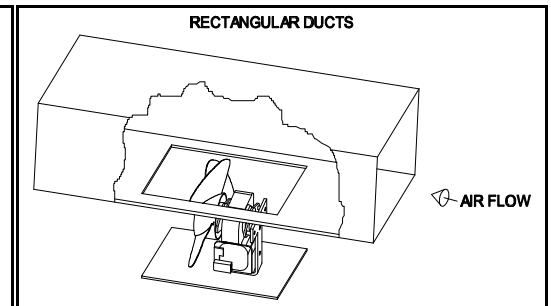

Figure 3B

UNIT WIRING INSTRUCTIONS

ELECTRICAL DATA

VOLTS	AMPS	HZ	WATTS	RPM	THERMAL OR IMPEDANCE PROTECTION
120 VAC	.60	60	35	3000	YES

A permanent wiring method must be used for power connection. It is recommended that a minimum size of 14 AWG wire for electrical supply connections and wiring should be suitable for 90°C (194°F) temperature. The Air Booster should be wired with an overcurrent protection device (fuse or circuit breaker) rated 15 amperes or less. Wiring method should be in accordance with the National Electrical Code and any local code requirements.

CAUTION: Disconnect electrical power before wiring. Do not route electrical wiring along heated duct pipes.

WIRING METHOD NO. 1

Controlling the Air Booster through a standard on/off wall switch. (See Figure 4 for wiring diagram) This method allows for manual control of the Air Booster unit in the area desired.

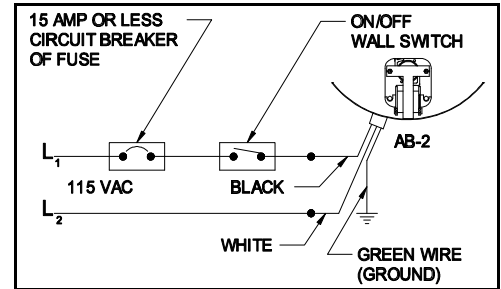

Figure 4

WIRING METHOD NO. 2

Controlling the Air Booster through a central heating/air conditioning forced air system. (See Figure 5 for wiring diagram) This method allows for automatic operation of the Air Booster unit. The Air Booster is wired in parallel with the appliance blower motor. This operates the Air Booster whenever the appliance blower operates.

CAUTION: Do not wire the Air Booster to an appliance blower motor if:

The appliance motor is not rated for 120 volts AC single phase and operating at 60 cycles.

The blower motor control is a variable speed tap type, solid state speed control or any of the type of controls not designed for dual motor control.

Consult appliance manual for this information.

NOTE: All wire splice connections should be made within an electrical junction box.

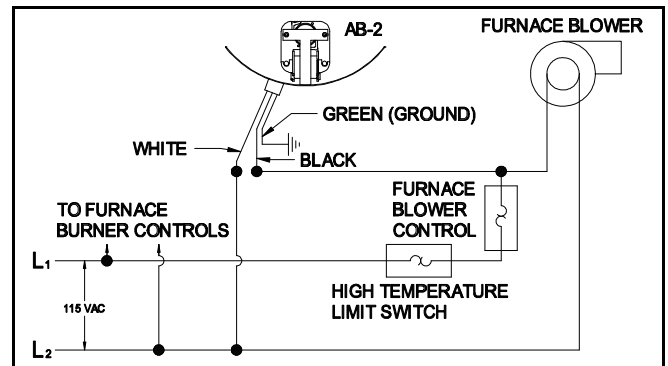

Figure 5

MAINTENANCE

CAUTION: Disconnect electrical power supply before performing maintenance.

Periodic removal and cleaning of the Air Booster unit is recommended for forced central heating/air conditioning systems. Annual removal and cleaning of the Air Booster unit is recommended for gravity warm air heating systems not equipped with a return air filter.

